



NRG70 Stable DOOR

70mm PVCu Stable Door



Platinum[®]
NRG

OPTIONAL



Chamfered bead

OPTIONAL



Sculptured bead

www.platinumnrg.co.uk

NRG70 Stable DOOR

Platinum[®]
NRG

HARDWARE OPTIONS



Two styles – modern (shown) or classic scrolled Lever/ Lever and Lever/ Pad combinations available. Aluminium and stainless steel construction.



STANDARD FINISHES

PlatinumNRG Chamfered

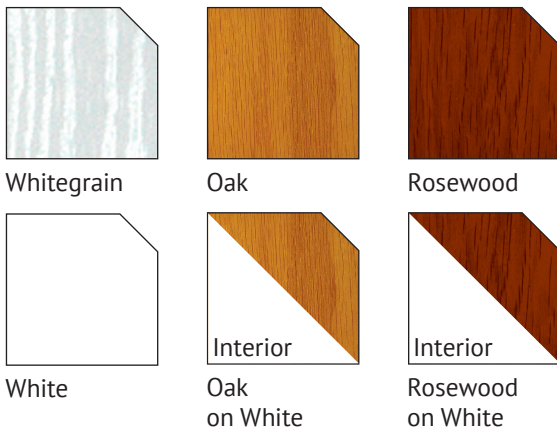

PlatinumNRG Sculptured

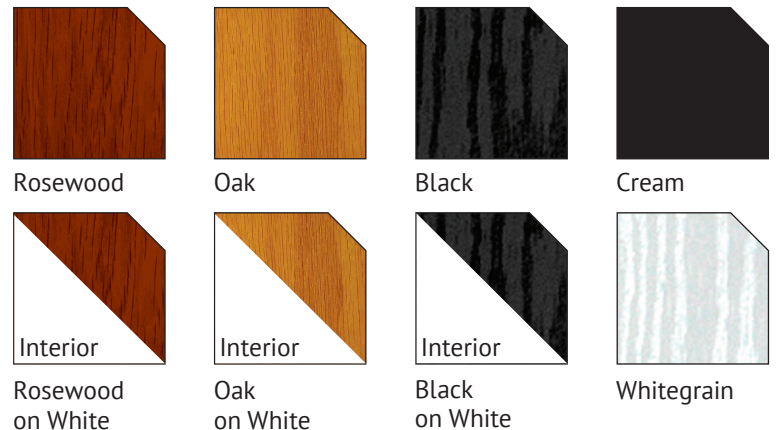

OPTIONAL FINISHES

A wide range of woodgrain and coloured-foil options are available for either or both internal and external faces or even differing frames and sashes.



www.platinumnrg.co.uk

NRG70 Stable DOOR

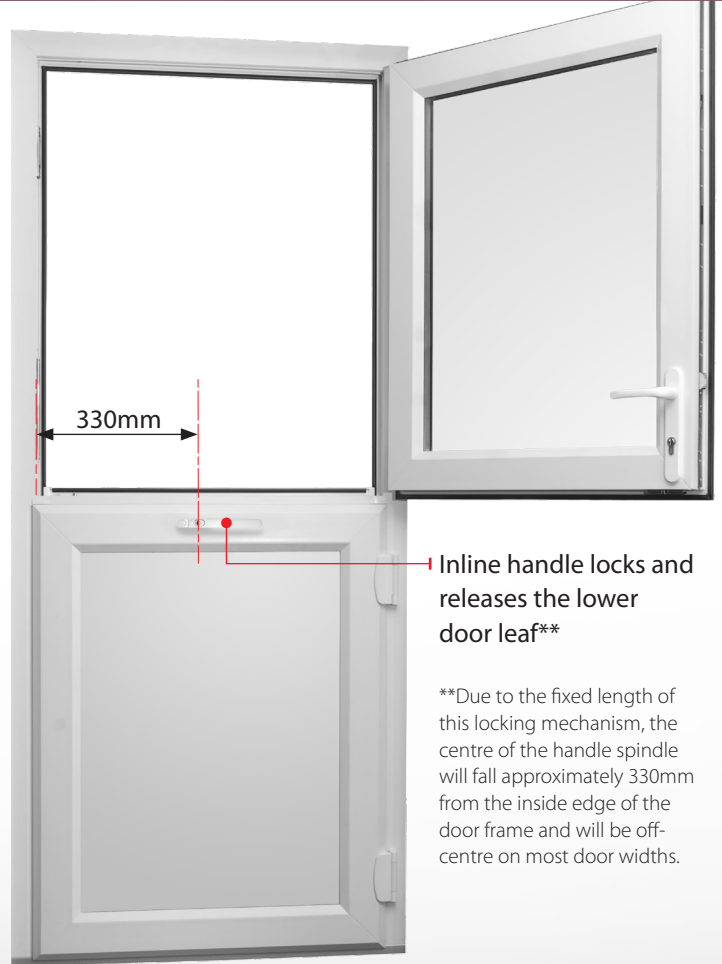

Inline handle locks and releases the lower door leaf**

**Due to the fixed length of this locking mechanism, the centre of the handle spindle will fall approximately 330mm from the inside edge of the door frame and will be off-centre on most door widths.

HINGES



SFS



HAVEN

Choice of hinges ensure ease-of-use and a draft-free fit and use stainless steel stabilising pins for enhanced security. Available in a choice of colours to match your door.

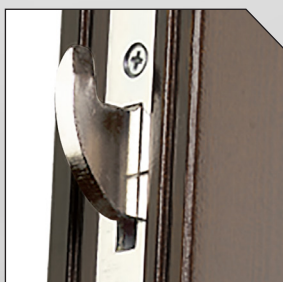

Special hook bolt for high level security. Made from high quality, rust free, stainless steel for longer life performance.



DRIP BAR

**Platinum**[®]
NRG

NRG70 Stable DOOR

THIS EXAMPLE SHOWS THE **CHAMFERED FRAME** IN AN **INWARD-OPENING** CONFIGURATION

100% LEAD FREE PVCu
Completely free of poisonous lead stabilisers.

GLOSS FINISH
Polished finish reduces cleaning and maintenance and retains a cleaner look for longer helping resist airborne pollutants and moulds.

DOUBLE-GLAZED UNIT
available for entire door or by using additional transoms and mullions just for parts of the door.

SOLID REINFORCED PANELS
available for entire door or by using additional transoms and mullions just for parts of the door.

Weather bar

LOW PVCu threshold

Stub cill

THRESHOLD OPTIONS

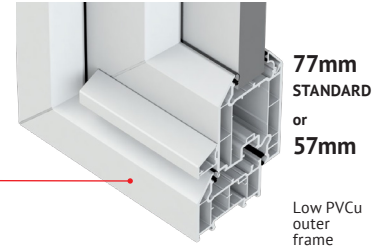

FRAME ONLY

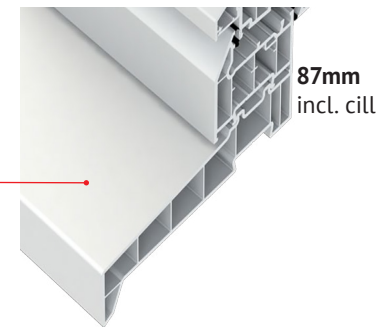

FRAME AND CILL

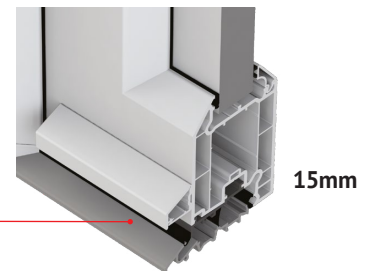

ALUMINIUM PART M COMPLIANT

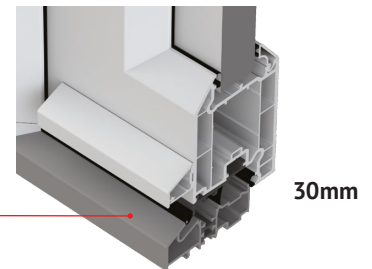

ALUMINIUM LOW THRESHOLD

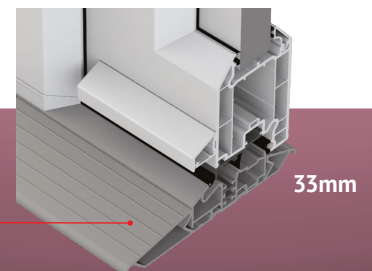

ALUMINIUM LOW THRESHOLD AND TRAY RAMP

